

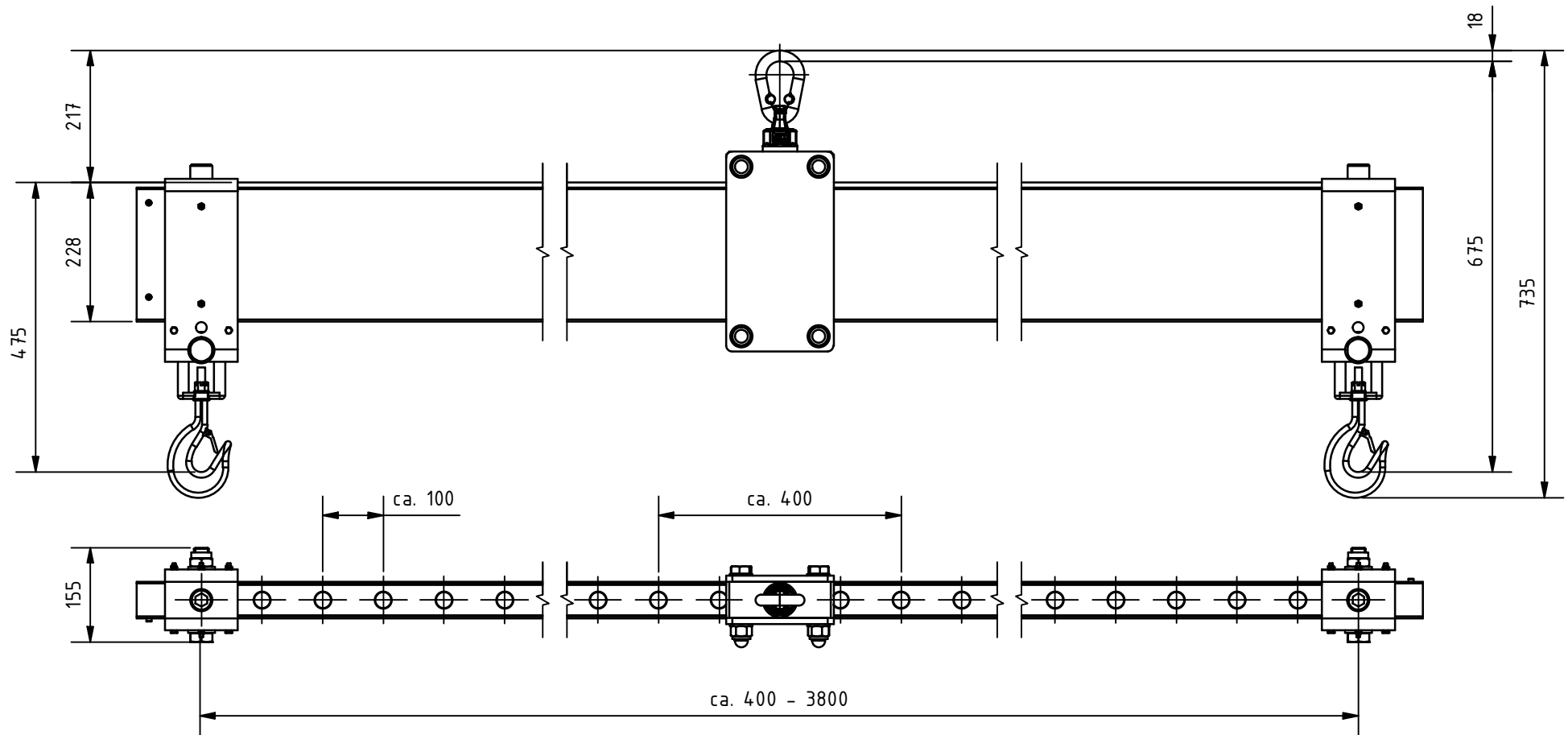

Änd. 6	Änderungsdatum 10.12.2024	Änderung durch Bettina Neuwirth		Allgemeintoleranz ISO 2768 - mK	Artikelnummer 522040	Format A4
 <a href="http://www.schilling-fn.de">www.schilling-fn.de</a> <small>           ■ SCHILLING Kran- und Hebertechnik GmbH            ■ Ernst-Zimmermann-Straße 9-11            ■ 88045 Friedrichshafen            ■ Deutschland         </small>			Zeichnungsnummer 522040-000		Masse 81,66 kg	Maßstab 1 : 15
			Titel, zusätzlicher Titel  <b>Lasttraverse</b>		Werkstoff	
			Erstellungsdatum 11.01.2021	Erstellt durch Danny Büdinger	Blatt 1/3	



Änd. 6	Änderungsdatum 10.12.2024	Änderung durch Bettina Neuwirth		Allgemeintoleranz ISO 2768 - mK	Artikelnummer 522040	Format A4
 <a href="http://www.schilling-fn.de">www.schilling-fn.de</a> <small>           ■ SCHILLING Kran- und Hebertechnik GmbH            ■ Ernst-Zimmermann-Straße 9-11            ■ 88045 Friedrichshafen            ■ Deutschland         </small>			Zeichnungsnummer 522040-000		Masse 81,66 kg	Maßstab 1 : 10
			Titel, zusätzlicher Titel  <b>Lasttraverse</b>		Werkstoff	