

Änd. 5	Änderungsdatum 01.10.2024	Änderung durch Bettina Neuwirth		Allgemeintoleranz ISO 2768 - mK	Artikelnummer 523030	Format A4
 www.schilling-fn.de <small> ■ SCHILLING Kran- und Hebertechnik GmbH ■ Ernst-Zimmermann-Straße 9-11 ■ 88045 Friedrichshafen ■ Deutschland </small>			Zeichnungsnummer 523030-000		Masse 68,64 kg	Maßstab 1 : 15
			Titel, zusätzlicher Titel Lasttraverse		Werkstoff	

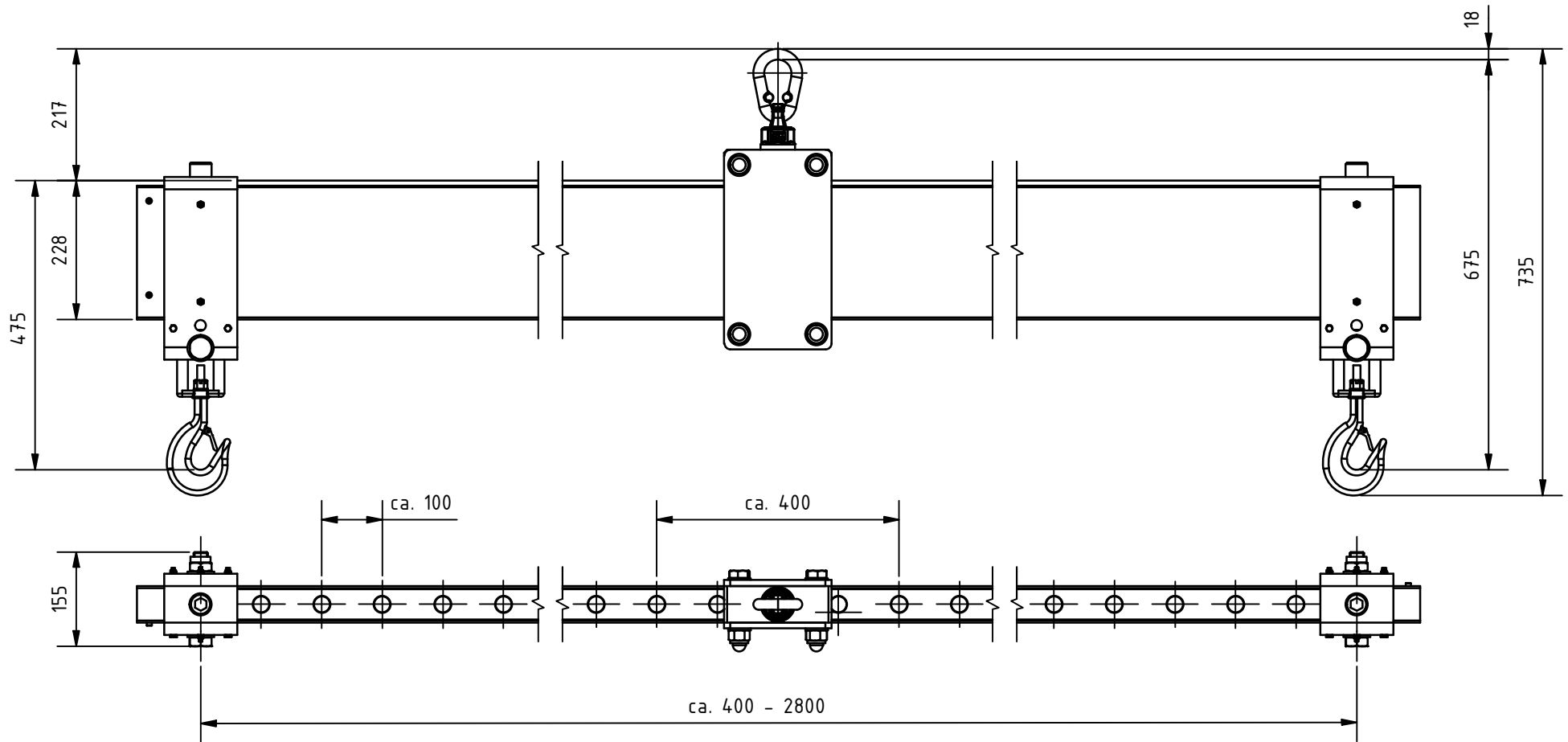

Änd. 5	Änderungsdatum 01.10.2024	Änderung durch Bettina Neuwirth		Allgemeintoleranz ISO 2768 - mK	Artikelnummer 523030	Format A4
 www.schilling-fn.de <small> ■ SCHILLING Kran- und Hebertechnik GmbH ■ Ernst-Zimmermann-Straße 9-11 ■ 88045 Friedrichshafen ■ Deutschland </small>			Zeichnungsnummer 523030-000		Masse 68,64 kg	Maßstab 1 : 10
			Titel, zusätzlicher Titel Lasttraverse		Werkstoff	