

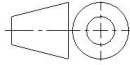



Änd. 2	Änderungsdatum 04.04.2025	Änderung durch Bettina Neuwirth		Allgemeintoleranz ISO 2768 - mK	Artikelnummer 53152030	Format A4
 www.schilling-fn.de <small> ■ SCHILLING Kran- und Hebertechnik GmbH ■ Ernst-Zimmermann-Straße 9-11 ■ 88045 Friedrichshafen ■ Deutschland </small>			Zeichnungsnummer 53152030-000		Masse 114,44 kg	Maßstab 1 : 20
			Titel, zusätzlicher Titel H- Traverse		Werkstoff	

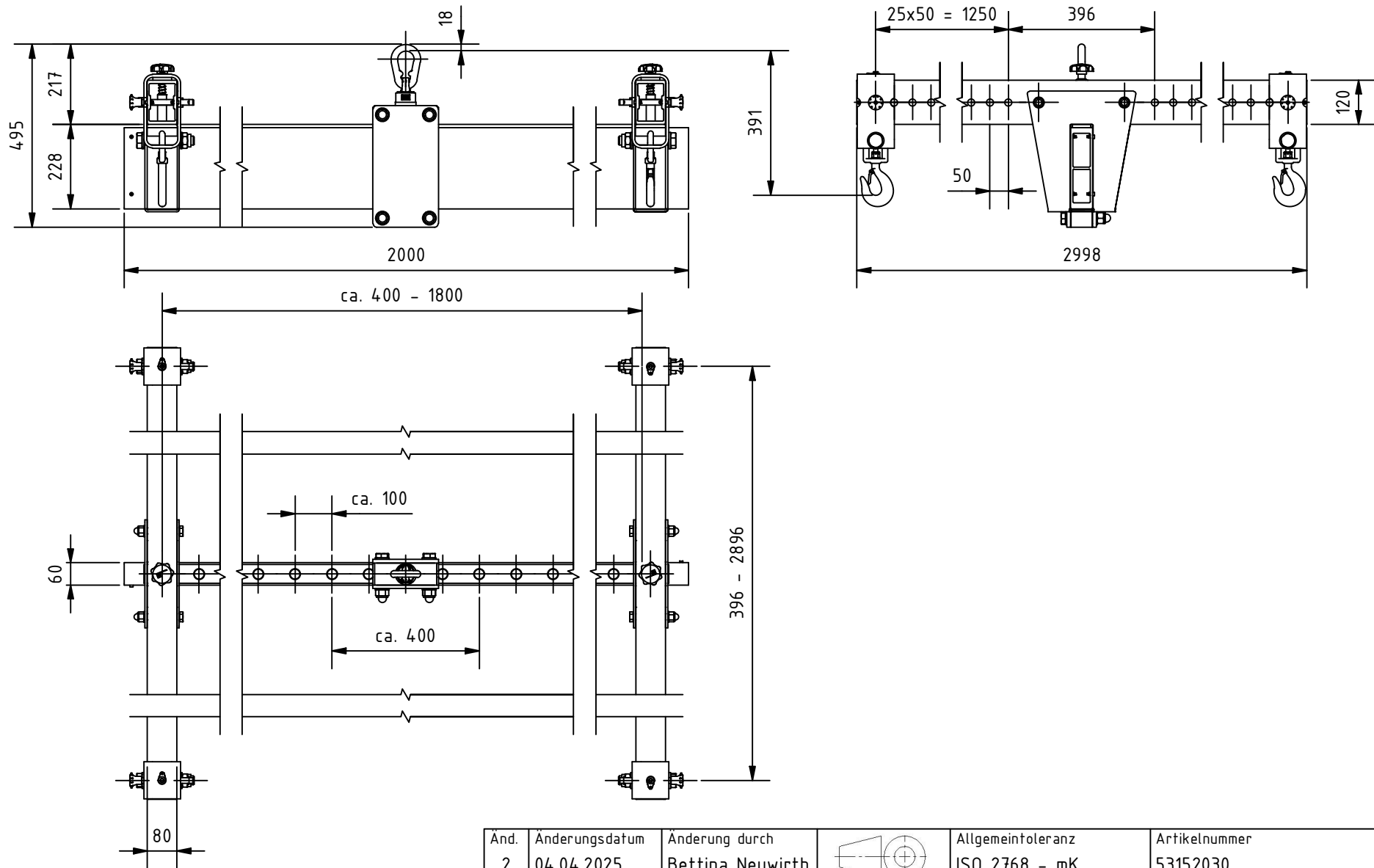
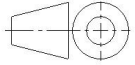

Änd. 2	Änderungsdatum 04.04.2025	Änderung durch Bettina Neuwirth		Allgemeintoleranz ISO 2768 - mK	Artikelnummer 53152030	Format A4
 www.schilling-fn.de ■ SCHILLING Kran- und Hebertechnik GmbH ■ Ernst-Zimmermann-Straße 9-11 ■ 88045 Friedrichshafen ■ Deutschland				Zeichnungsnummer 53152030-000		Maßstab 1 : 15
				Titel, zusätzlicher Titel H-Traverse		Werkstoff
			Erstellungsdatum 13.01.2022	Erstellt durch Bettina Neuwirth	Blatt 2/3	