

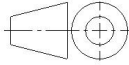



Änd. 2	Änderungsdatum 08.06.2026	Änderung durch Bettina Neuwirth		Allgemeintoleranz ISO 2768 - mK	Artikelnummer 53153030	Format A4
 www.schilling-fn.de <small> ■ SCHILLING Kran- und Hebertechnik GmbH ■ Ernst-Zimmermann-Straße 9-11 ■ 88045 Friedrichshafen ■ Deutschland </small>			Zeichnungsnummer 53153030-000		Masse 129,12 kg	Maßstab 1 : 20
			Titel, zusätzlicher Titel H-Traverse		Werkstoff	

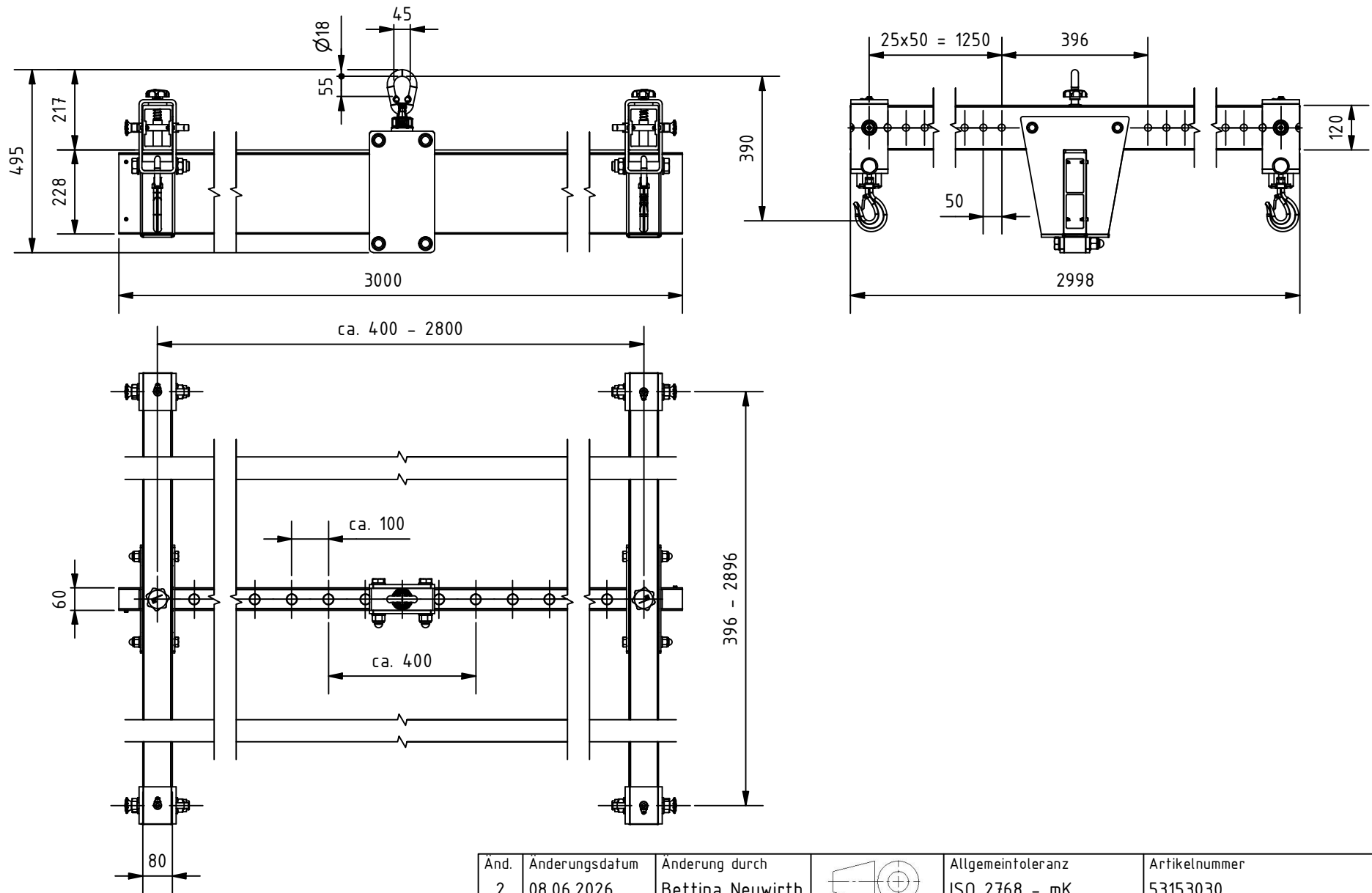
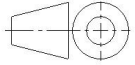

Änd. 2	Änderungsdatum 08.06.2026	Änderung durch Bettina Neuwirth		Allgemeintoleranz ISO 2768 - mK	Artikelnummer 53153030	Format A4
 www.schilling-fn.de ■ SCHILLING Kran- und Hebertechnik GmbH ■ Ernst-Zimmermann-Straße 9-11 ■ 88045 Friedrichshafen ■ Deutschland				Zeichnungsnummer 53153030-000		Maßstab 1 : 15
				Titel, zusätzlicher Titel H-Traverse		Werkstoff
			Erstellungsdatum 13.01.2022	Erstellt durch Bettina Neuwirth	Blatt 2/3	