

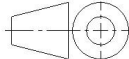



Änd. 2	Änderungsdatum 04.04.2025	Änderung durch Bettina Neuwirth		Allgemeintoleranz ISO 2768 - mK	Artikelnummer 53154030	Format A4
 <a href="http://www.schilling-fn.de">www.schilling-fn.de</a> <b>SCHILLING Kran- und Hebertechnik GmbH</b> Ernst-Zimmermann-Straße 9-11 88045 Friedrichshafen Deutschland			Zeichnungsnummer 53154030-000		Masse 142,47 kg	Maßstab 1 : 25
			Titel, zusätzlicher Titel  H-Traverse		Werkstoff	

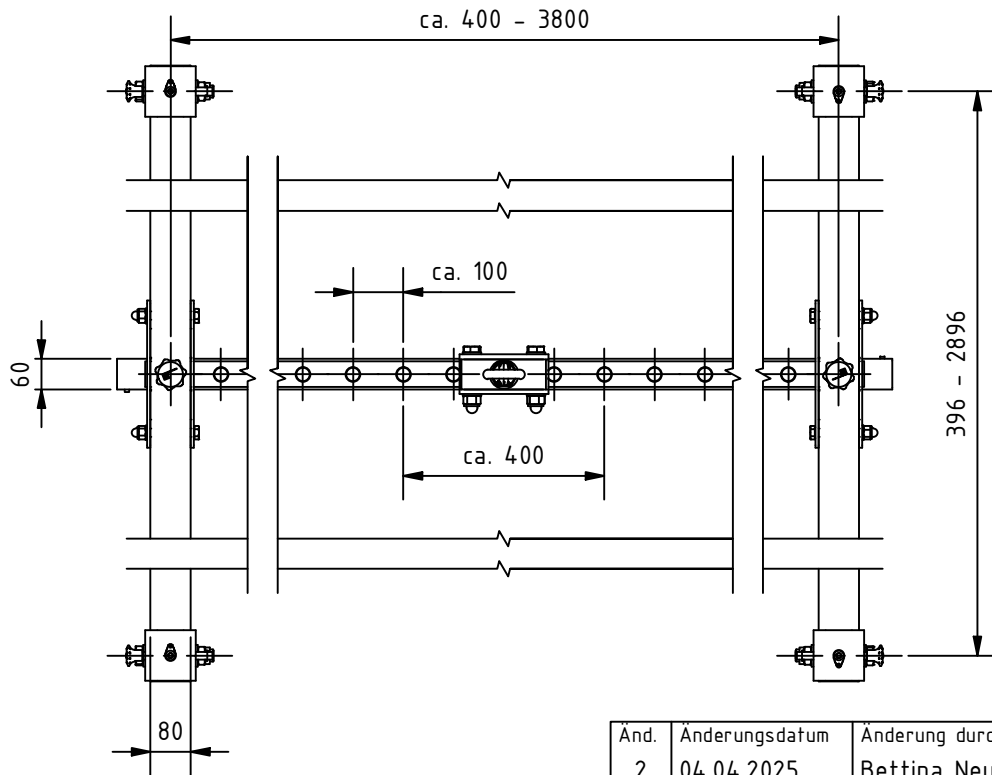
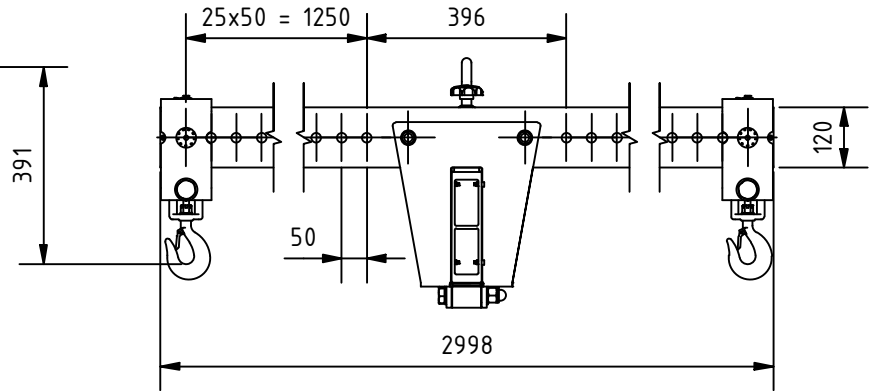
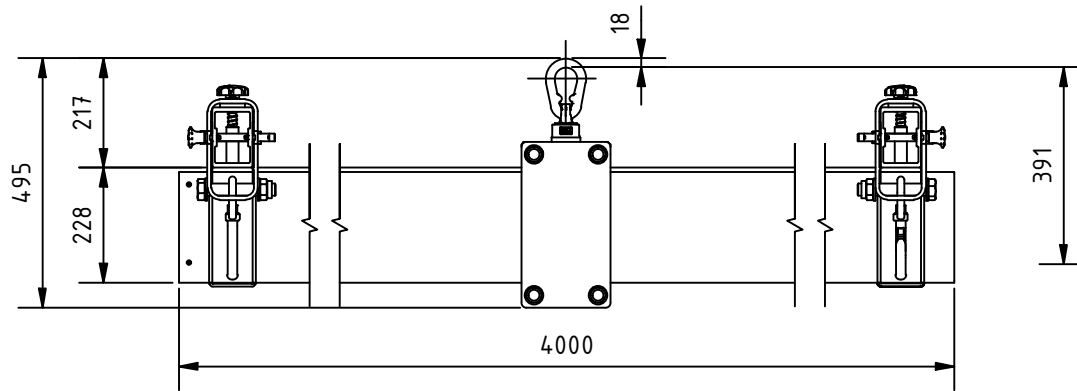
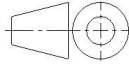

Änd. 2	Änderungsdatum 04.04.2025	Änderung durch Bettina Neuwirth		Allgemeintoleranz ISO 2768 - mK	Artikelnummer 53154030	Format A4
 <a href="http://www.schilling-fn.de">www.schilling-fn.de</a> ■ SCHILLING Kran- und Hebertechnik GmbH ■ Ernst-Zimmermann-Straße 9-11 ■ 88045 Friedrichshafen ■ Deutschland				Zeichnungsnummer 53154030-000		Maßstab 1 : 15
				Titel, zusätzlicher Titel  H-Traverse		Werkstoff
				Erstellungsdatum 13.01.2022	Erstellt durch Bettina Neuwirth	Blatt 2/3