

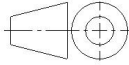



Änd. 4	Änderungsdatum 04.04.2025	Änderung durch Bettina Neuwirth		Allgemeintoleranz ISO 2768 - mK	Artikelnummer 53204020	Format A4
 www.schilling-fn.de <small> ■ SCHILLING Kran- und Hebertechnik GmbH ■ Ernst-Zimmermann-Straße 9-11 ■ 88045 Friedrichshafen ■ Deutschland </small>			Zeichnungsnummer 53204020-000		Masse 126,72 kg	Maßstab 1 : 20
			Titel, zusätzlicher Titel H-Traverse		Werkstoff	

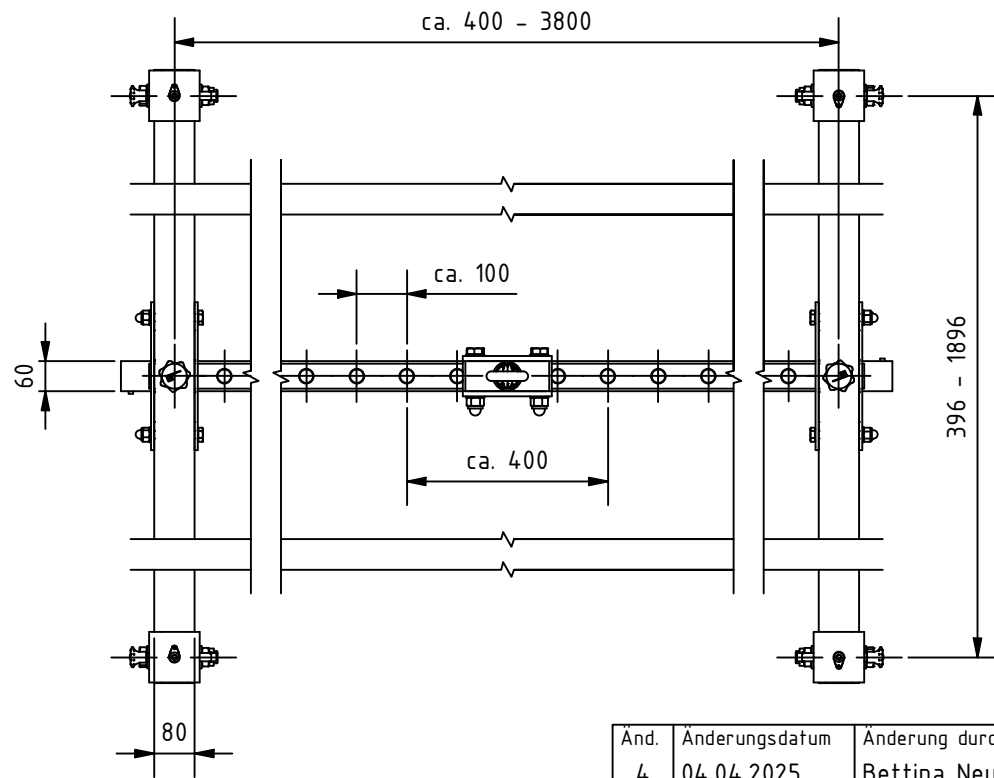
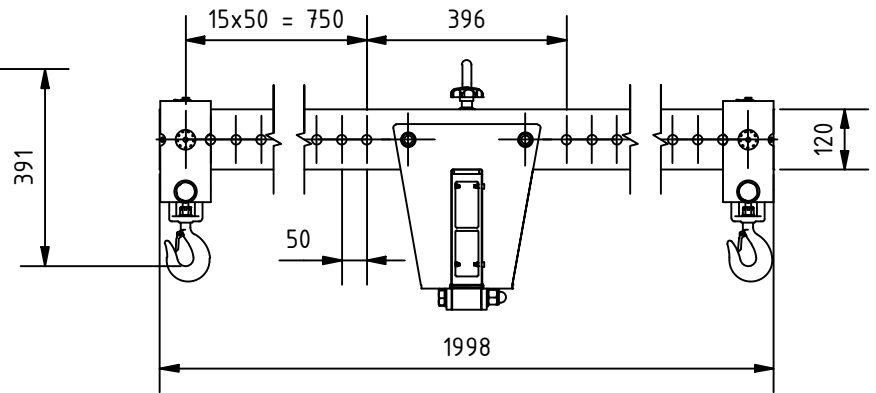
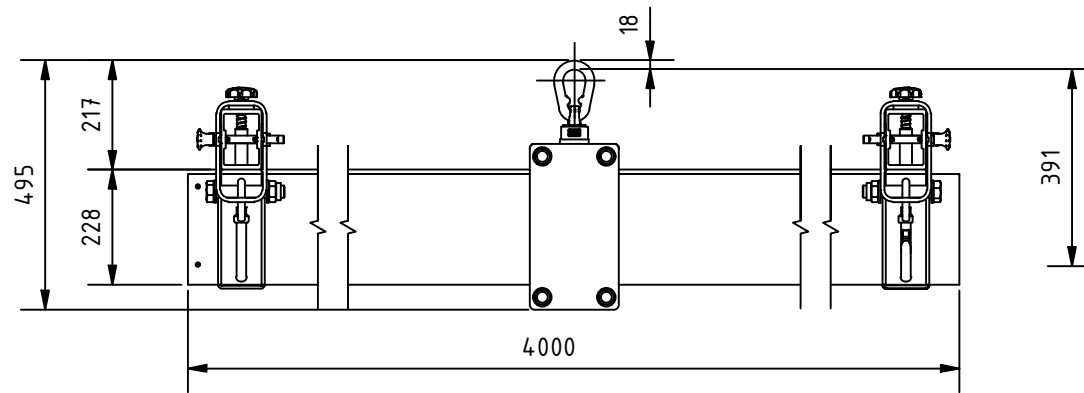
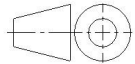

Änd. 4	Änderungsdatum 04.04.2025	Änderung durch Bettina Neuwirth		Allgemeintoleranz ISO 2768 - mK	Artikelnummer 53204020	Format A4
 www.schilling-fn.de ■ SCHILLING Kran- und Hebertechnik GmbH ■ Ernst-Zimmermann-Straße 9-11 ■ 88045 Friedrichshafen ■ Deutschland				Zeichnungsnummer 53204020-000		Maßstab 1 : 15
				Titel, zusätzlicher Titel H-Traverse		Werkstoff
				Erstellungsdatum 15.12.2020	Erstellt durch Bettina Neuwirth	Blatt 2/3