

Änd. 4	Änderungsdatum 13.11.2025	Änderung durch Bettina Neuwirth		Allgemeintoleranz ISO 2768 - mK	Artikelnummer 14602060-10	Format A4
 www.schilling-fn.de SCHILLING Kran- und Hebertechnik GmbH Ernst-Zimmermann-Straße 9-11 88045 Friedrichshafen Deutschland Telefon: +49 7541 60404-0 E-Mail: mail@schilling-fn.de			Zeichnungsnummer 14602060-001		Masse 426,56 kg	Maßstab 1 : 40
			Titel, zusätzlicher Titel Portalkran		Werkstoff	
			Erstellungsdatum 25.03.2020	Erstellt durch Tobias Hornikel	Blatt 1/3	

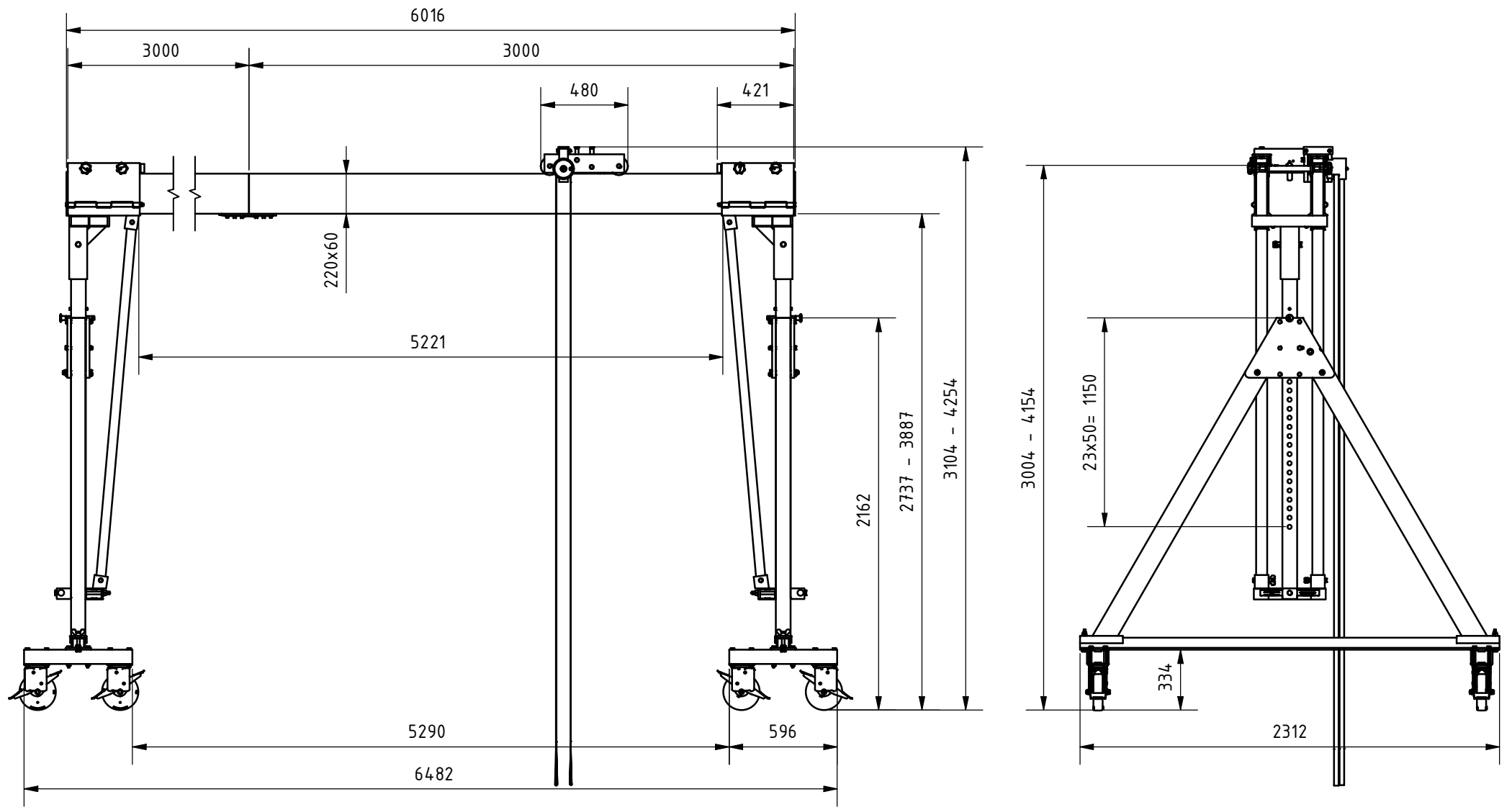

Änd. 4	Änderungsdatum 13.11.2025	Änderung durch Bettina Neuwirth		Allgemeintoleranz ISO 2768 - mK	Artikelnummer 14.602060-10	Format A4
 www.schilling-fn.de ■ SCHILLING Kran- und Hebertechnik GmbH ■ Ernst-Zimmermann-Straße 9-11 ■ 88045 Friedrichshafen ■ Deutschland			Zeichnungsnummer 14.602060-001		Masse 426,56 kg	Maßstab 1 : 30
			Titel, zusätzlicher Titel Portalkran		Werkstoff	