

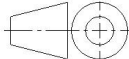
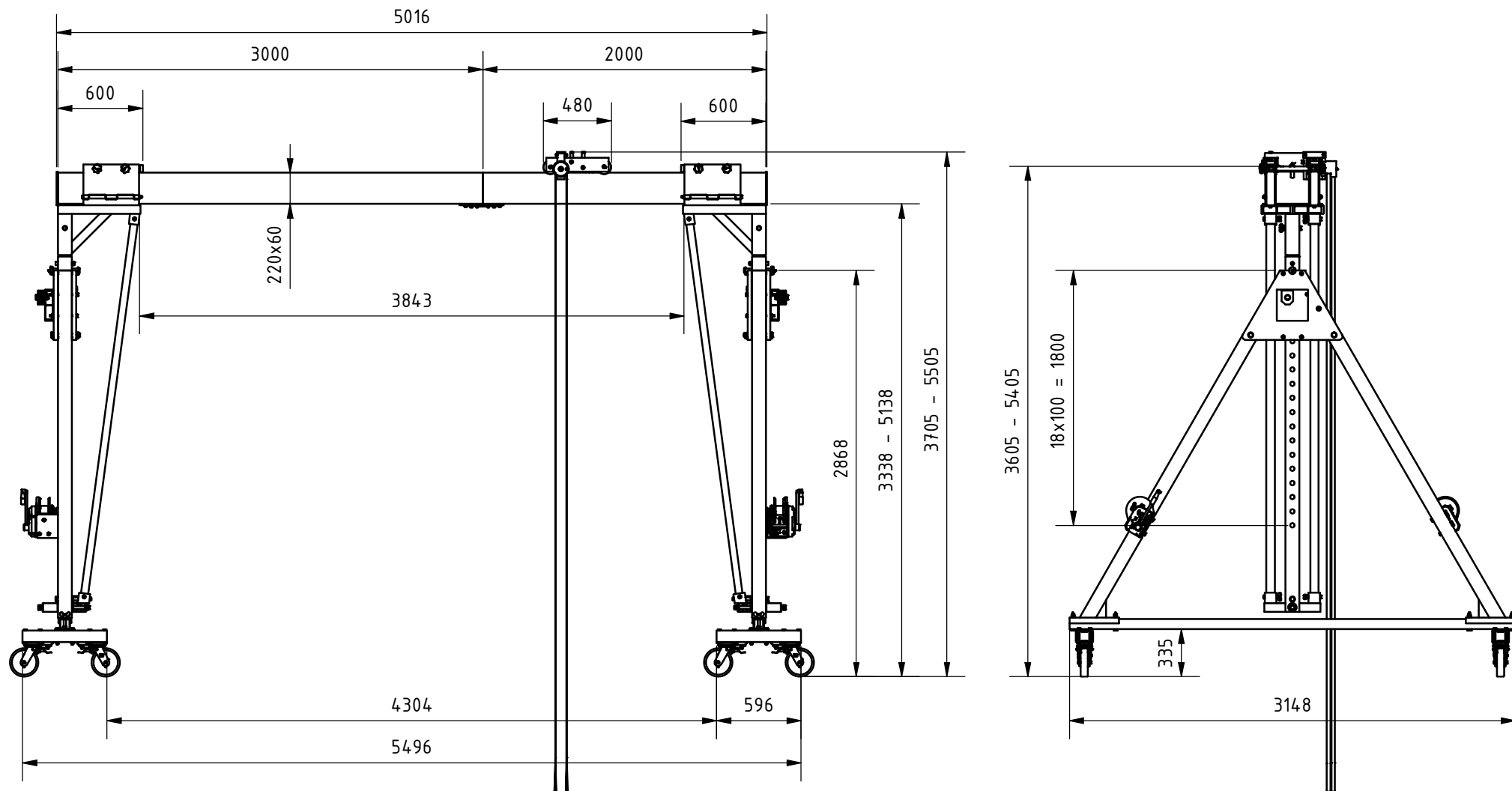

Änd. 0	Änderungsdatum 08.05.2026	Änderung durch Bettina Neuwirth		Allgemeintoleranz ISO 2768 - mK	Artikelnummer 14643050-10	Format A4
 www.schilling-fn.de <small> ■ SCHILLING Kran- und Hebertechnik GmbH ■ Ernst-Zimmermann-Straße 9-11 ■ 88045 Friedrichshafen ■ Deutschland </small>			Zeichnungsnummer 14643050-001		Masse 593,48 kg	Maßstab 1 : 40
			Titel, zusätzlicher Titel Portalkran		Werkstoff	
			Erstellungsdatum 08.05.2026		Erstellt durch Bettina Neuwirth	
					Blatt 1/3	



Änd. 0	Änderungsdatum 08.05.2026	Änderung durch Bettina Neuwirth		Allgemeintoleranz ISO 2768 - mK	Artikelnummer 14643050-10	Format A4
 www.schilling-fn.de ■ SCHILLING Kran- und Hebertechnik GmbH ■ Ernst-Zimmermann-Straße 9-11 ■ 88045 Friedrichshafen ■ Deutschland			Zeichnungsnummer 14643050-001		Masse 593,48 kg	Maßstab 1 : 40
			Titel, zusätzlicher Titel Portalkran		Werkstoff	