

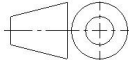



Änd. 2	Änderungsdatum 25.07.2025	Änderung durch Bettina Neuwirth		Allgemeintoleranz ISO 2768 - mK	Artikelnummer 1310540-10	Format A4
 www.schilling-fn.de <small> ■ SCHILLING Kran- und Hebertechnik GmbH ■ Ernst-Zimmermann-Straße 9-11 ■ 88045 Friedrichshafen ■ Deutschland </small>			Zeichnungsnummer 1310540-001		Masse 110,56 kg	Maßstab 1 : 25
			Titel, zusätzlicher Titel Portalkran		Werkstoff	

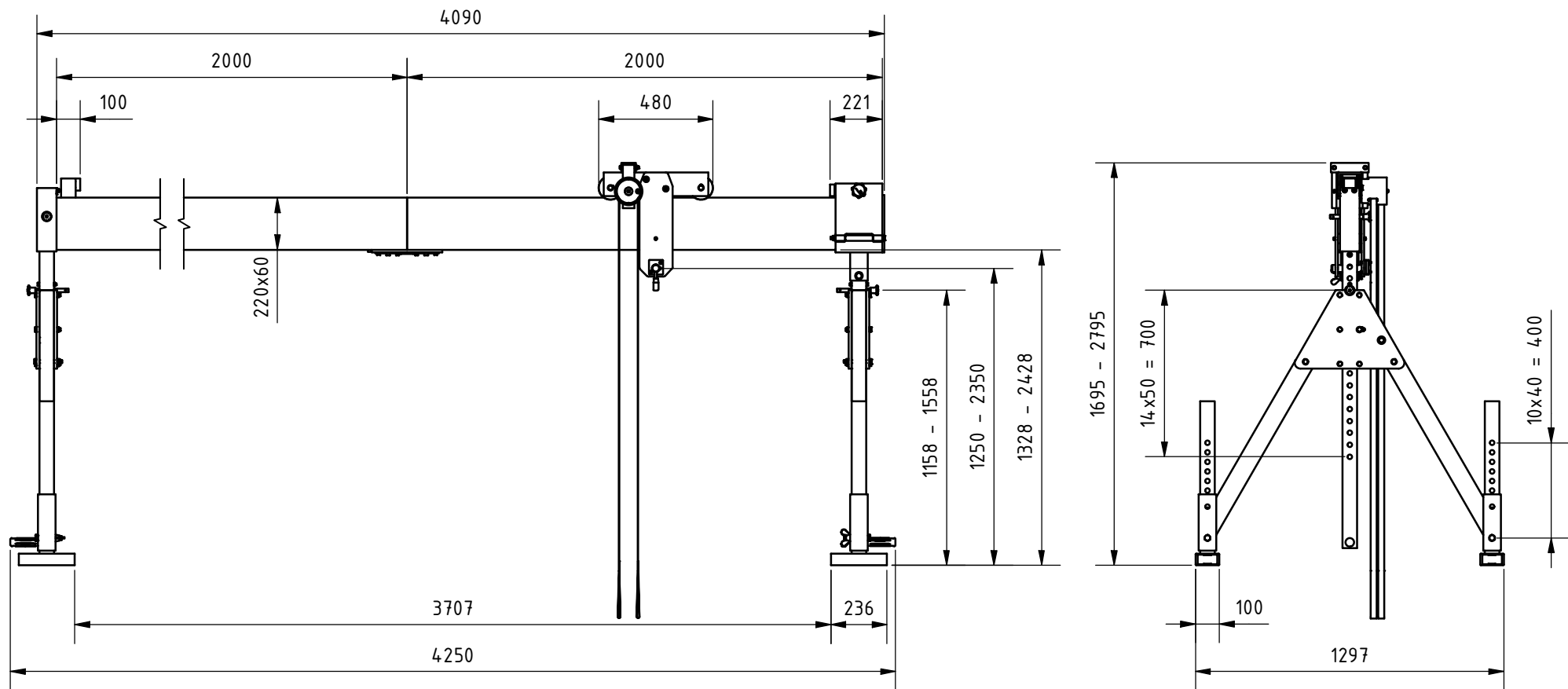
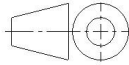

Änd. 2	Änderungsdatum 25.07.2025	Änderung durch Bettina Neuwirth		Allgemeintoleranz ISO 2768 - mK	Artikelnummer 1310540-10	Format A4
 www.schilling-fn.de ■ SCHILLING Kran- und Hebertechnik GmbH ■ Ernst-Zimmermann-Straße 9-11 ■ 88045 Friedrichshafen ■ Deutschland			Zeichnungsnummer 1310540-001		Masse 110,56 kg	Maßstab 1 : 25
			Titel, zusätzlicher Titel Portalkran		Werkstoff	