

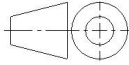



Änd. 2	Änderungsdatum 03.05.2023	Änderung durch Bettina Neuwirth		Allgemeintoleranz ISO 2768 - mK	Artikelnummer 14.91040-10	Format A4
 <a href="http://www.schilling-fn.de">www.schilling-fn.de</a> <small>           ■ SCHILLING Kran- und Hebertechnik GmbH            ■ Ernst-Zimmermann-Straße 9-11            ■ 88045 Friedrichshafen            ■ Deutschland         </small>			Zeichnungsnummer 14.91040-001		Masse 229,00 kg	Maßstab 1 : 30
			Titel, zusätzlicher Titel  Portalkran		Werkstoff	

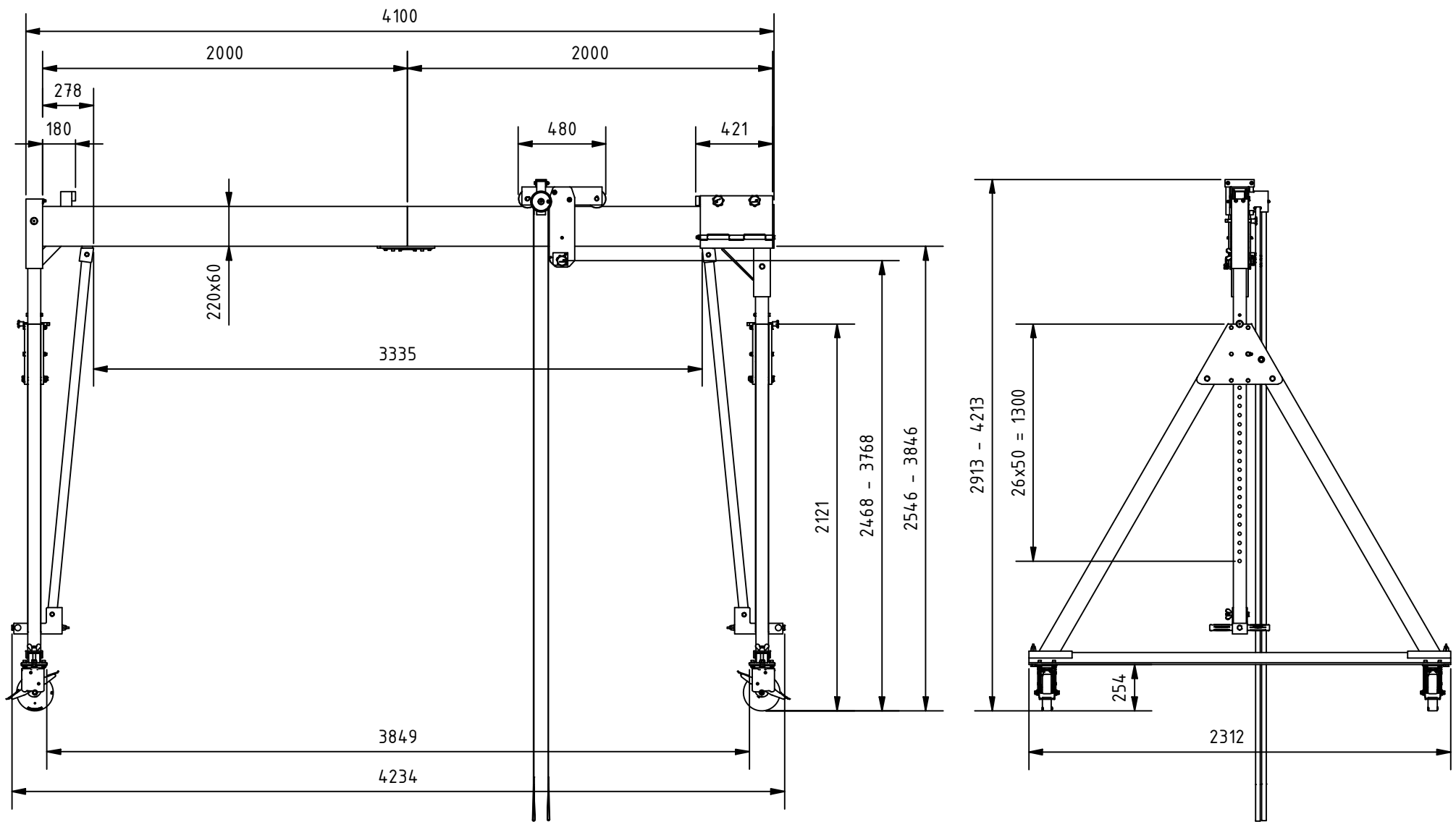
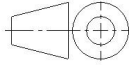

Änd. 2	Änderungsdatum 03.05.2023	Änderung durch Bettina Neuwirth		Allgemeintoleranz ISO 2768 - mK	Artikelnummer 14.91040-10	Format A4
 <a href="http://www.schilling-fn.de">www.schilling-fn.de</a> ■ SCHILLING Kran- und Hebertechnik GmbH ■ Ernst-Zimmermann-Straße 9-11 ■ 88045 Friedrichshafen ■ Deutschland			Zeichnungsnummer 14.91040-001		Masse 229,00 kg	Maßstab 1 : 30
			Titel, zusätzlicher Titel  Portalkran		Werkstoff	