

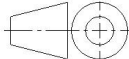
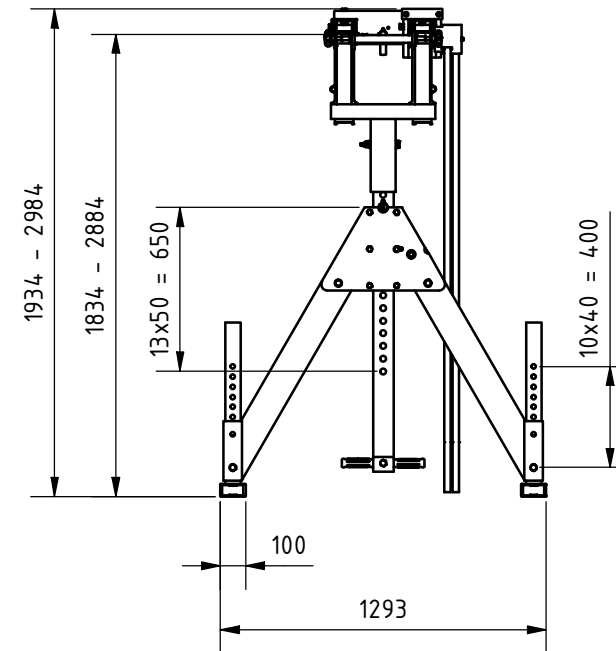

Änd. 6	Änderungsdatum 13.11.2025	Änderung durch Bettina Neuwirth		Allgemeintoleranz ISO 2768 - mK	Artikelnummer 1511040-10	Format A4
 www.schilling-fn.de ■ SCHILLING Kran- und Hebertechnik GmbH ■ Ernst-Zimmermann-Straße 9-11 ■ 88045 Friedrichshafen ■ Deutschland			Zeichnungsnummer 1511040-001		Masse 244,05 kg	Maßstab 1 : 25
			Titel, zusätzlicher Titel Portalkran		Werkstoff	

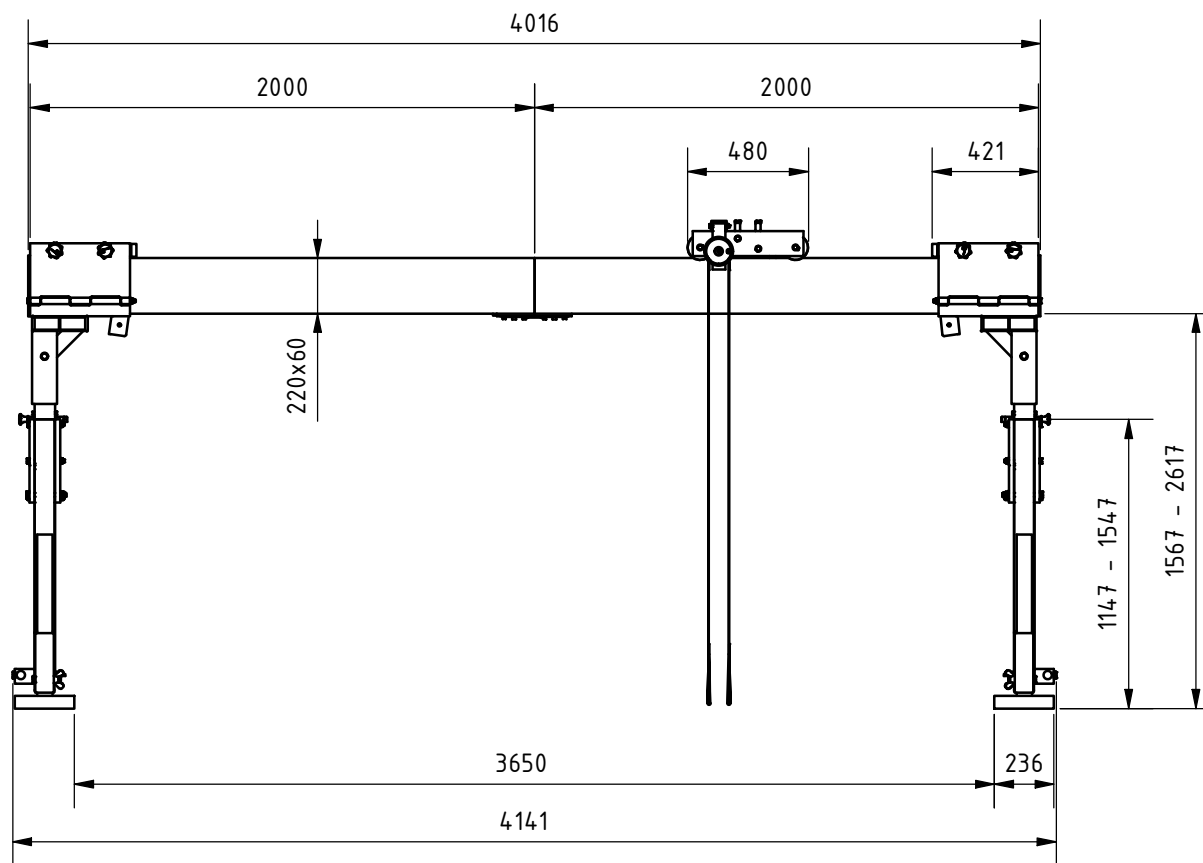

Änd. 6	Änderungsdatum 13.11.2025	Änderung durch Bettina Neuwirth		Allgemeintoleranz ISO 2768 - mK	Artikelnummer 1511040-10	Format A4
 www.schilling-fn.de ■ SCHILLING Kran- und Hebertechnik GmbH ■ Ernst-Zimmermann-Straße 9-11 ■ 88045 Friedrichshafen ■ Deutschland			Zeichnungsnummer 1511040-001		Masse 244,05 kg	Maßstab 1 : 30
			Titel, zusätzlicher Titel Portalkran		Werkstoff	