

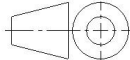



Änd. 5	Änderungsdatum 13.11.2025	Änderung durch Bettina Neuwirth		Allgemeintoleranz ISO 2768 - mK	Artikelnummer 1511070-10	Format A4
 www.schilling-fn.de ■ SCHILLING Kran- und Hebertechnik GmbH ■ Ernst-Zimmermann-Straße 9-11 ■ 88045 Friedrichshafen ■ Deutschland			Zeichnungsnummer 1511070-001		Masse 296,28 kg	Maßstab 1 : 35
			Titel, zusätzlicher Titel Portalkran		Werkstoff	

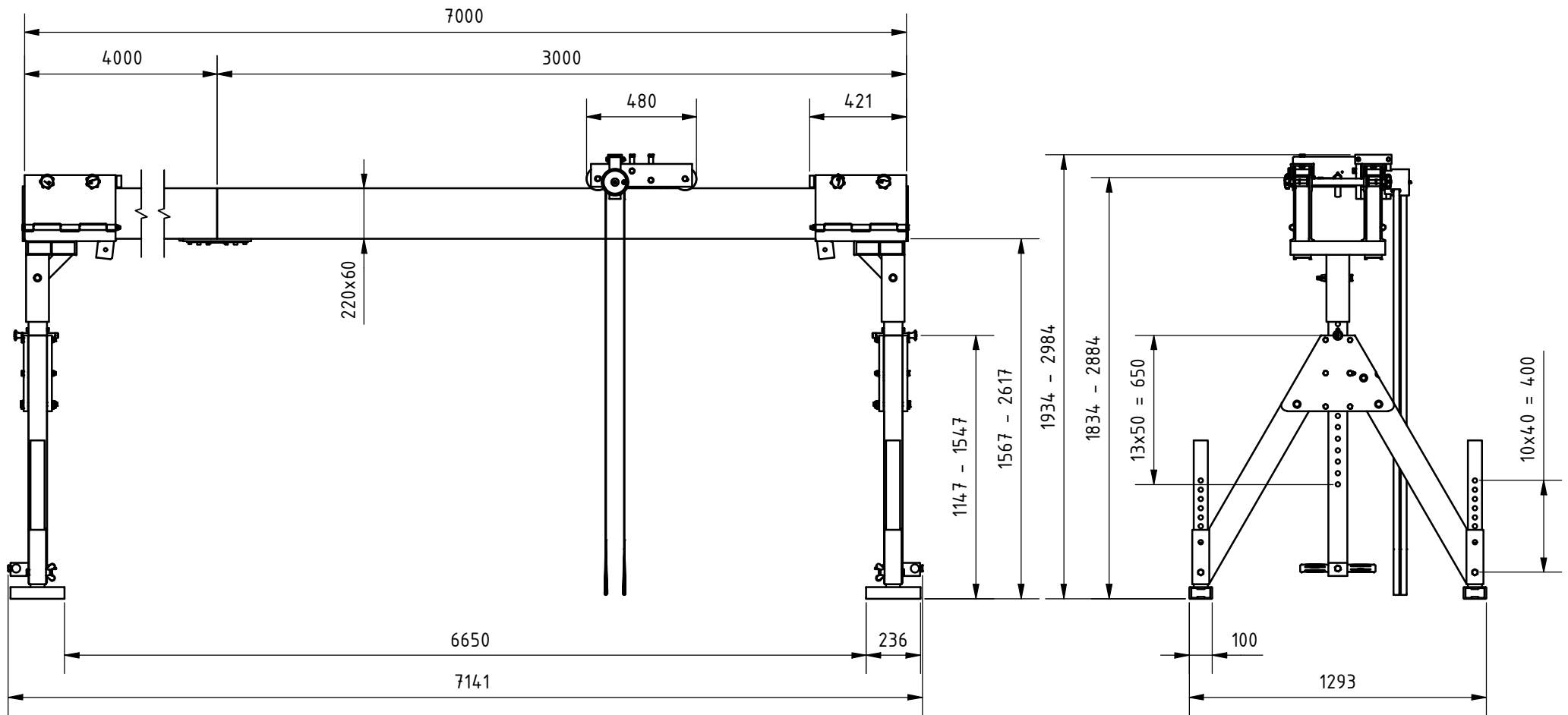
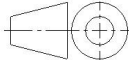

Änd. 5	Änderungsdatum 13.11.2025	Änderung durch Bettina Neuwirth		Allgemeintoleranz ISO 2768 - mK	Artikelnummer 1511070-10	Format A4
 www.schilling-fn.de ■ SCHILLING Kran- und Hebertechnik GmbH ■ Ernst-Zimmermann-Straße 9-11 ■ 88045 Friedrichshafen ■ Deutschland			Zeichnungsnummer 1511070-001		Masse 296,28 kg	Maßstab 1 : 25
			Titel, zusätzlicher Titel Portalkran		Werkstoff	