

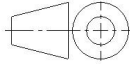



| | | | | | | |
|--|------------------------------|------------------------------------|---|------------------------------------|-----------------------------|-------------------|
| Änd. 7 | Änderungsdatum 19.11.2025 | Änderung durch Bettina Neuwirth |  | Allgemeintoleranz ISO 2768 - mK | Artikelnummer 1511560-10 | Format A4 |
|  www.schilling-fn.de <small> ■ SCHILLING Kran- und Hebertechnik GmbH ■ Ernst-Zimmermann-Straße 9-11 ■ 88045 Friedrichshafen ■ Deutschland </small> | | | Zeichnungsnummer 1511560-001 | | Masse 278,87 kg | Maßstab 1 : 30 |
| | | | Titel, zusätzlicher Titel Portalkran | | Werkstoff | |

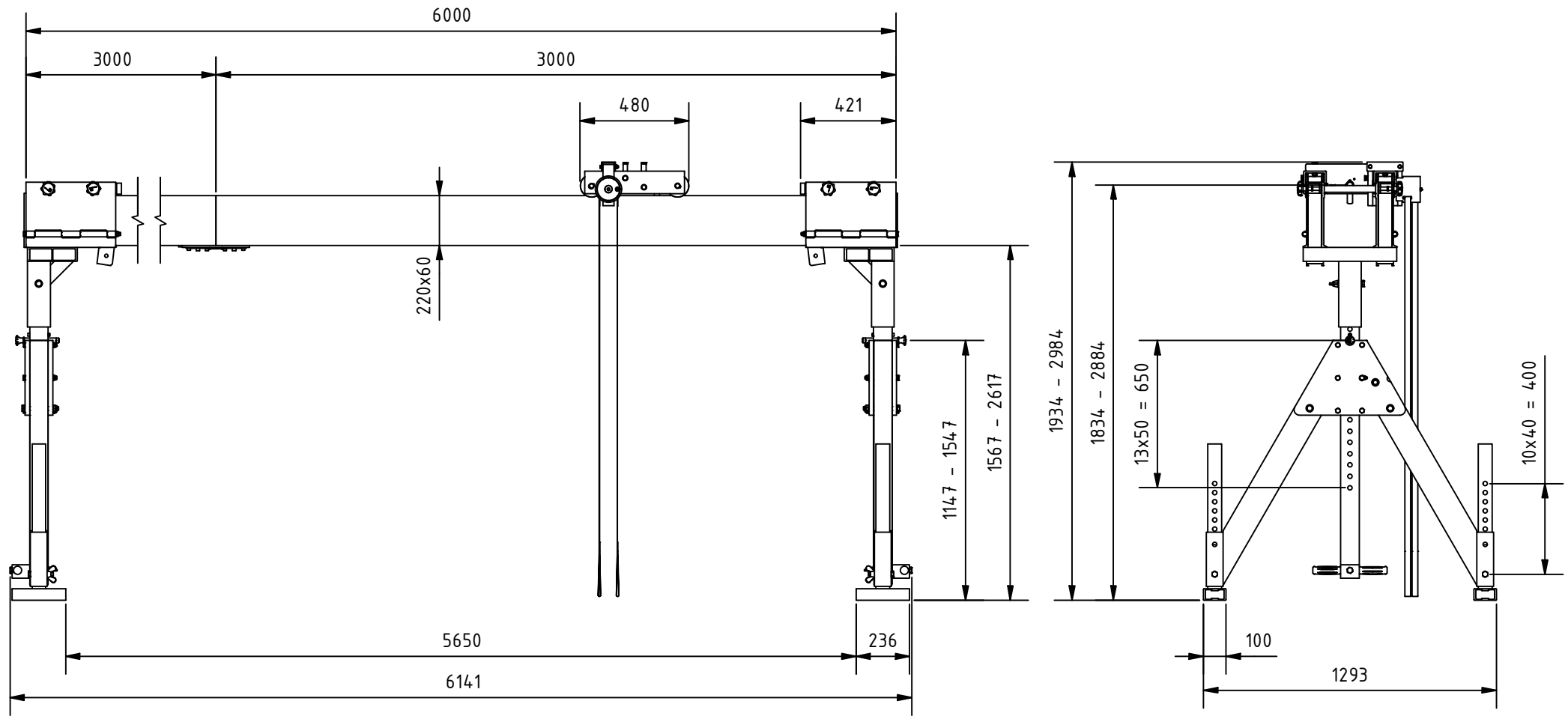
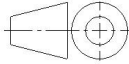

| | | | | | | |
|---|------------------------------|------------------------------------|---|------------------------------------|-----------------------------|-------------------|
| Änd. 7 | Änderungsdatum 19.11.2025 | Änderung durch Bettina Neuwirth |  | Allgemeintoleranz ISO 2768 - mK | Artikelnummer 1511560-10 | Format A4 |
|  www.schilling-fn.de ■ SCHILLING Kran- und Hebertechnik GmbH ■ Ernst-Zimmermann-Straße 9-11 ■ 88045 Friedrichshafen ■ Deutschland | | | Zeichnungsnummer 1511560-001 | | Masse 278,87 kg | Maßstab 1 : 25 |
| | | | Titel, zusätzlicher Titel Portalkran | | Werkstoff | |