

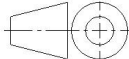



Änd. 1	Änderungsdatum 25.07.2025	Änderung durch Bettina Neuwirth		Allgemeintoleranz ISO 2768 - mK	Artikelnummer 1310550-10	Format A4
 www.schilling-fn.de <small> ■ SCHILLING Kran- und Hebertechnik GmbH ■ Ernst-Zimmermann-Straße 9-11 ■ 88045 Friedrichshafen ■ Deutschland </small>			Zeichnungsnummer 1310550-001		Masse 128,77 kg	Maßstab 1 : 30
			Titel, zusätzlicher Titel Portalkran		Werkstoff	
			Erstellungsdatum 26.02.2025		Erstellt durch Bettina Neuwirth	Blatt 1/3

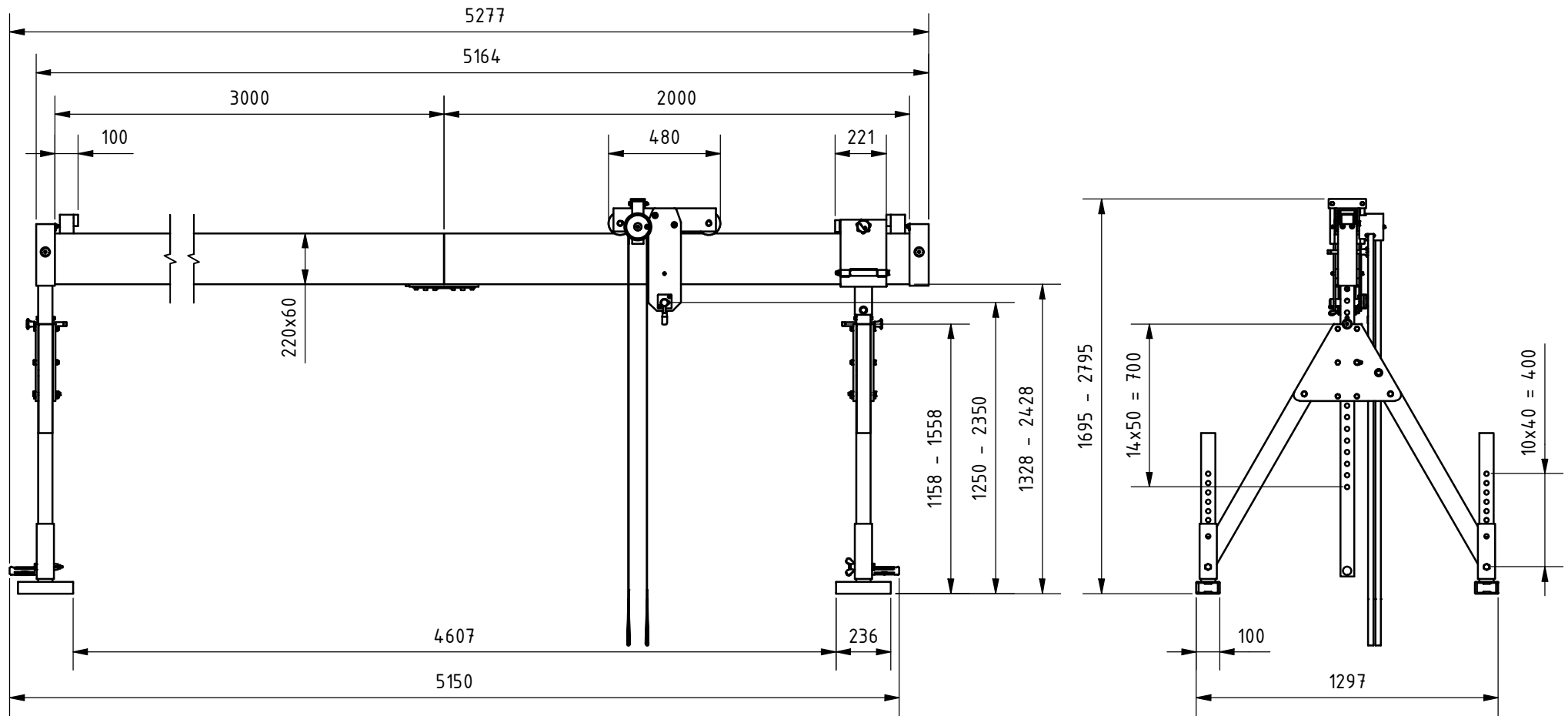

Änd. 1	Änderungsdatum 25.07.2025	Änderung durch Bettina Neuwirth		Allgemeintoleranz ISO 2768 - mK	Artikelnummer 1310550-10	Format A4
 www.schilling-fn.de ■ SCHILLING Kran- und Hebertechnik GmbH ■ Ernst-Zimmermann-Straße 9-11 ■ 88045 Friedrichshafen ■ Deutschland			Zeichnungsnummer 1310550-001		Masse 128,77 kg	Maßstab 1 : 25
			Titel, zusätzlicher Titel Portalkran		Werkstoff	