

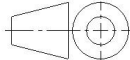



Änd. 5	Änderungsdatum 07.11.2025	Änderung durch Bettina Neuwirth		Allgemeintoleranz ISO 2768 - mK	Artikelnummer 1532080-10	Format A4
 www.schilling-fn.de <small> ■ SCHILLING Kran- und Hebertechnik GmbH ■ Ernst-Zimmermann-Straße 9-11 ■ Telefon: +49 7541 60404-0 ■ 88045 Friedrichshafen ■ E-Mail: mail@schilling-fn.de ■ Deutschland </small>			Zeichnungsnummer 1532080-001		Masse 422,74 kg	Maßstab 1 : 45
			Titel, zusätzlicher Titel Portalkran		Werkstoff	

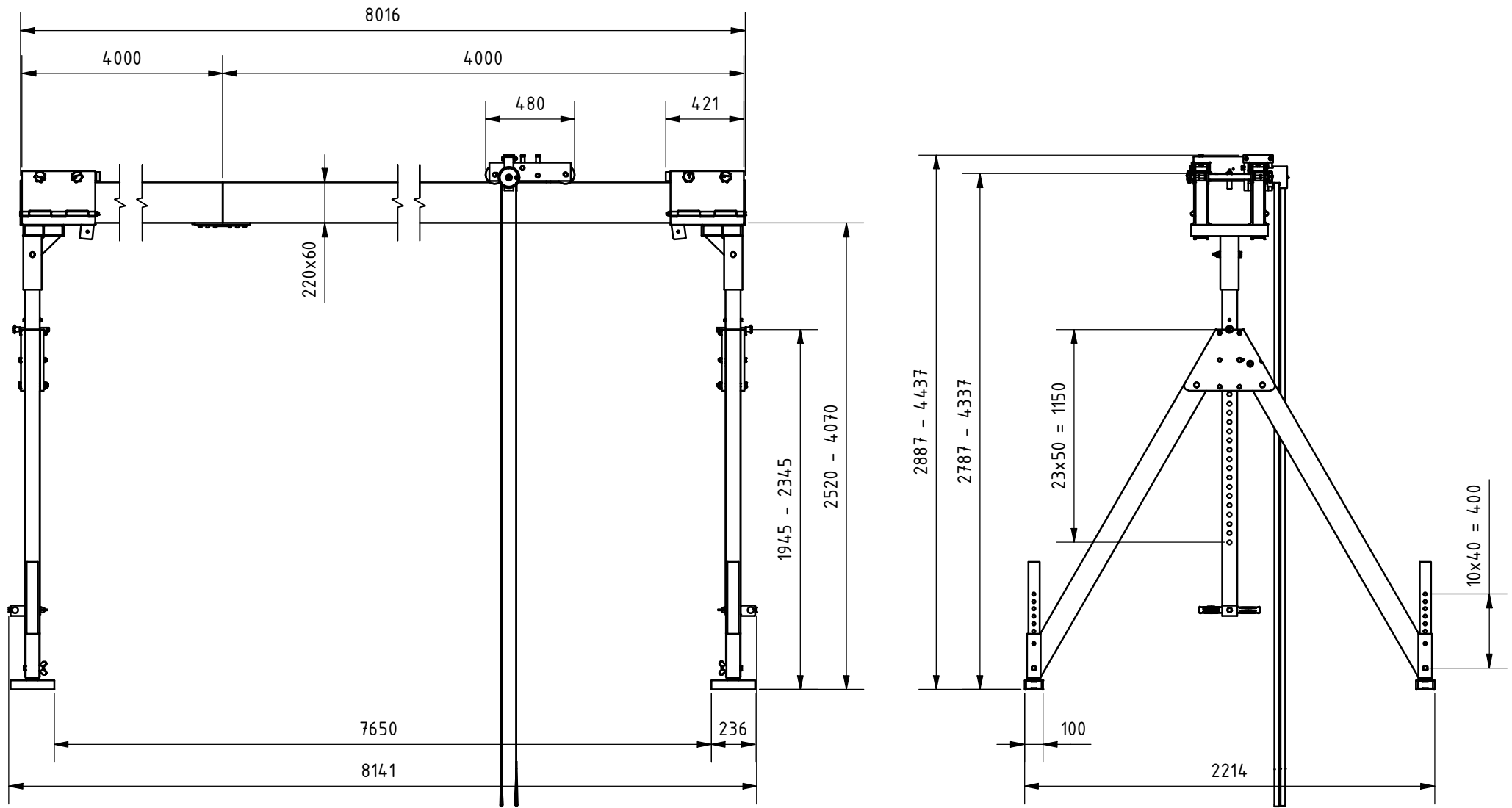
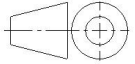

Änd. 5	Änderungsdatum 07.11.2025	Änderung durch Bettina Neuwirth		Allgemeintoleranz ISO 2768 - mK	Artikelnummer 1532080-10	Format A4
 www.schilling-fn.de ■ SCHILLING Kran- und Hebetechnik GmbH ■ Ernst-Zimmermann-Straße 9-11 ■ 88045 Friedrichshafen ■ Deutschland			Zeichnungsnummer 1532080-001		Masse 422,74 kg	Maßstab 1 : 30
			Titel, zusätzlicher Titel Portalkran		Werkstoff	