

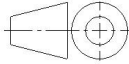



Änd. 3	Änderungsdatum 04.12.2025	Änderung durch Bettina Neuwirth		Allgemeintoleranz ISO 2768 - mK	Artikelnummer 1321040-10	Format A4
 www.schilling-fn.de <small> ■ SCHILLING Kran- und Hebertechnik GmbH ■ Ernst-Zimmermann-Straße 9-11 ■ 88045 Friedrichshafen ■ Deutschland </small>			Zeichnungsnummer 1321040-001		Masse 125,11 kg	Maßstab 1 : 30
			Titel, zusätzlicher Titel Portalkran		Werkstoff	

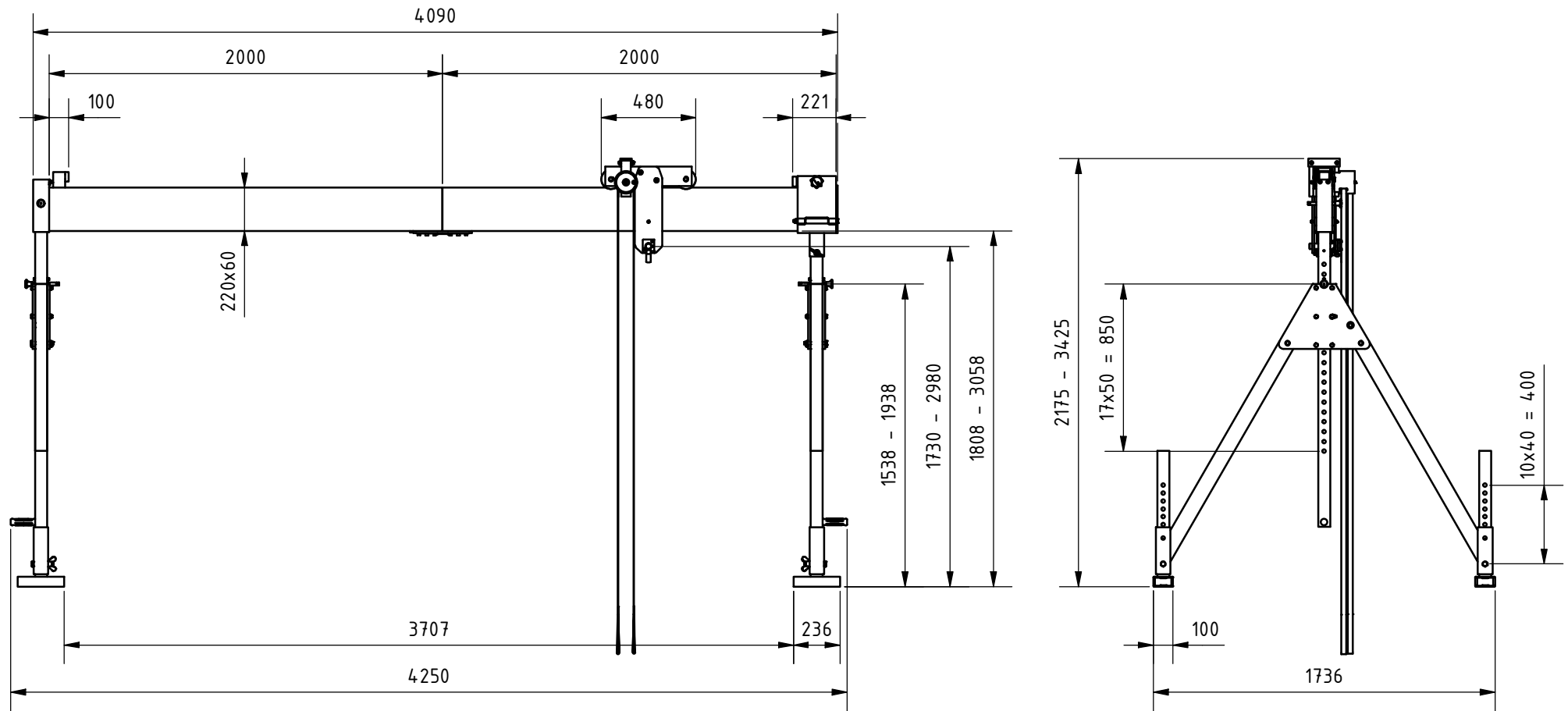
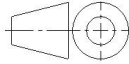

Änd. 3	Änderungsdatum 04.12.2025	Änderung durch Bettina Neuwirth		Allgemeintoleranz ISO 2768 - mK	Artikelnummer 1321040-10	Format A4
 www.schilling-fn.de ■ SCHILLING Kran- und Hebertechnik GmbH ■ Ernst-Zimmermann-Straße 9-11 ■ 88045 Friedrichshafen ■ Deutschland			Zeichnungsnummer 1321040-001		Masse 125,11 kg	Maßstab 1 : 30
			Titel, zusätzlicher Titel Portalkran		Werkstoff	