

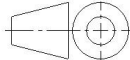



Änd. 2	Änderungsdatum 19.07.2022	Änderung durch Bettina Neuwirth		Allgemeintoleranz ISO 2768 - mK	Artikelnummer 1321060-10	Format A4
 www.schilling-fn.de SCHILLING Kran- und Hebertechnik GmbH Ernst-Zimmermann-Straße 9-11 Telefon: +49 7541 60404-0 88045 Friedrichshafen E-Mail: mail@schilling-fn.de Deutschland			Zeichnungsnummer 1321060-001		Masse 142,57 kg	Maßstab 1 : 35
			Titel, zusätzlicher Titel Portalkran		Werkstoff	
			Erstellungsdatum 10.05.2020	Erstellt durch Tobias Hornikel	Blatt 1/2	

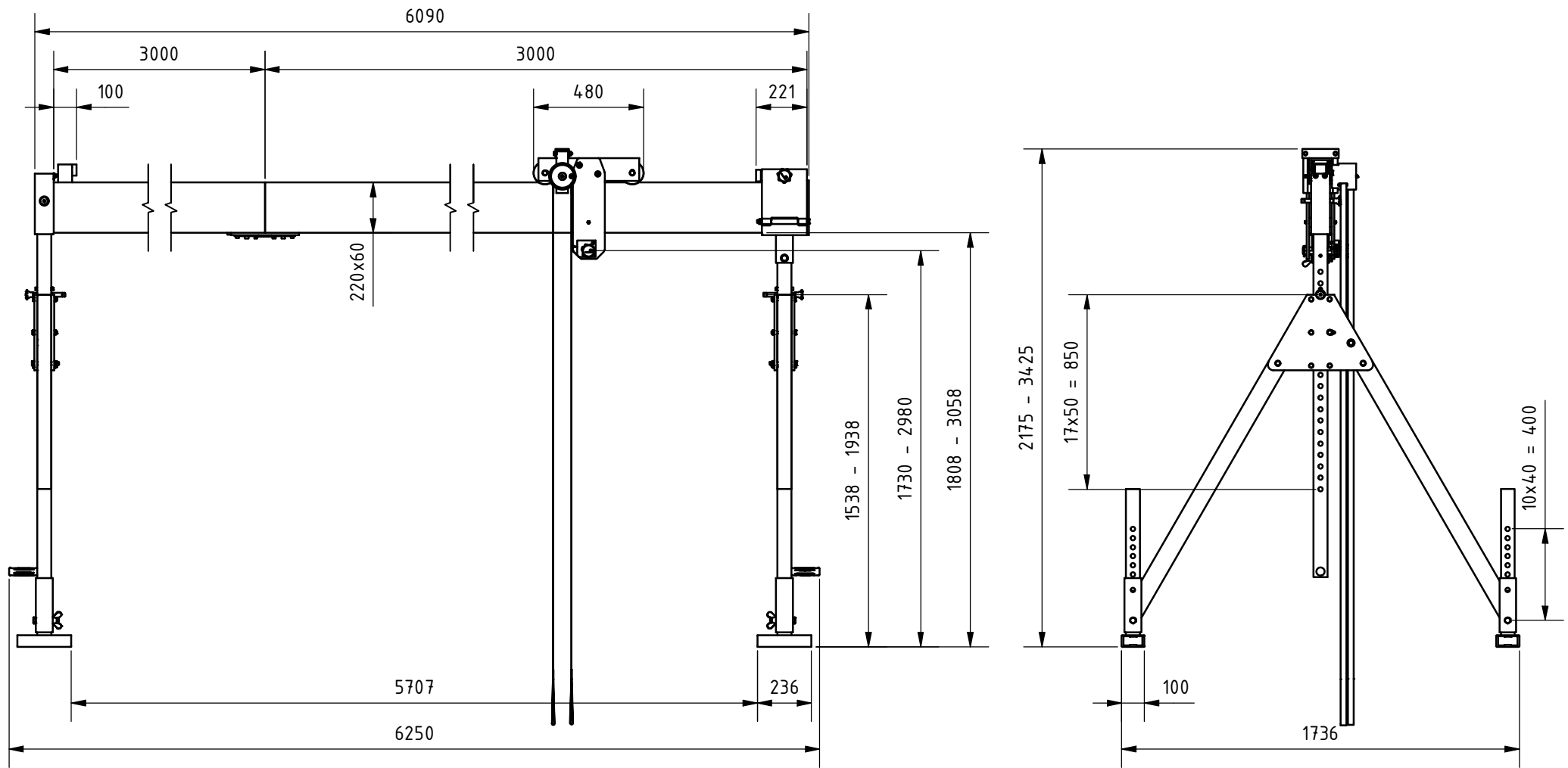
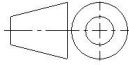

Änd. 2	Änderungsdatum 19.07.2022	Änderung durch Bettina Neuwirth		Allgemeintoleranz ISO 2768 - mK	Artikelnummer 1321060-10	Format A4
 www.schilling-fn.de ■ SCHILLING Kran- und Hebertechnik GmbH ■ Ernst-Zimmermann-Straße 9-11 ■ 88045 Friedrichshafen ■ Deutschland			Zeichnungsnummer 1321060-001		Masse 14,57 kg	Maßstab 1 : 25
			Titel, zusätzlicher Titel Portalkran		Werkstoff	