

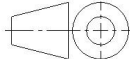



Änd. 1	Änderungsdatum 19.07.2022	Änderung durch Bettina Neuwirth		Allgemeintoleranz ISO 2768 - mK	Artikelnummer 1321070-10	Format A4
 www.schilling-fn.de ■ SCHILLING Kran- und Hebertechnik GmbH ■ Ernst-Zimmermann-Straße 9-11 ■ 88045 Friedrichshafen ■ Deutschland			Zeichnungsnummer 1321070-001		Masse 183,41 kg	Maßstab 1 : 35
			Titel, zusätzlicher Titel Portalkran		Werkstoff	

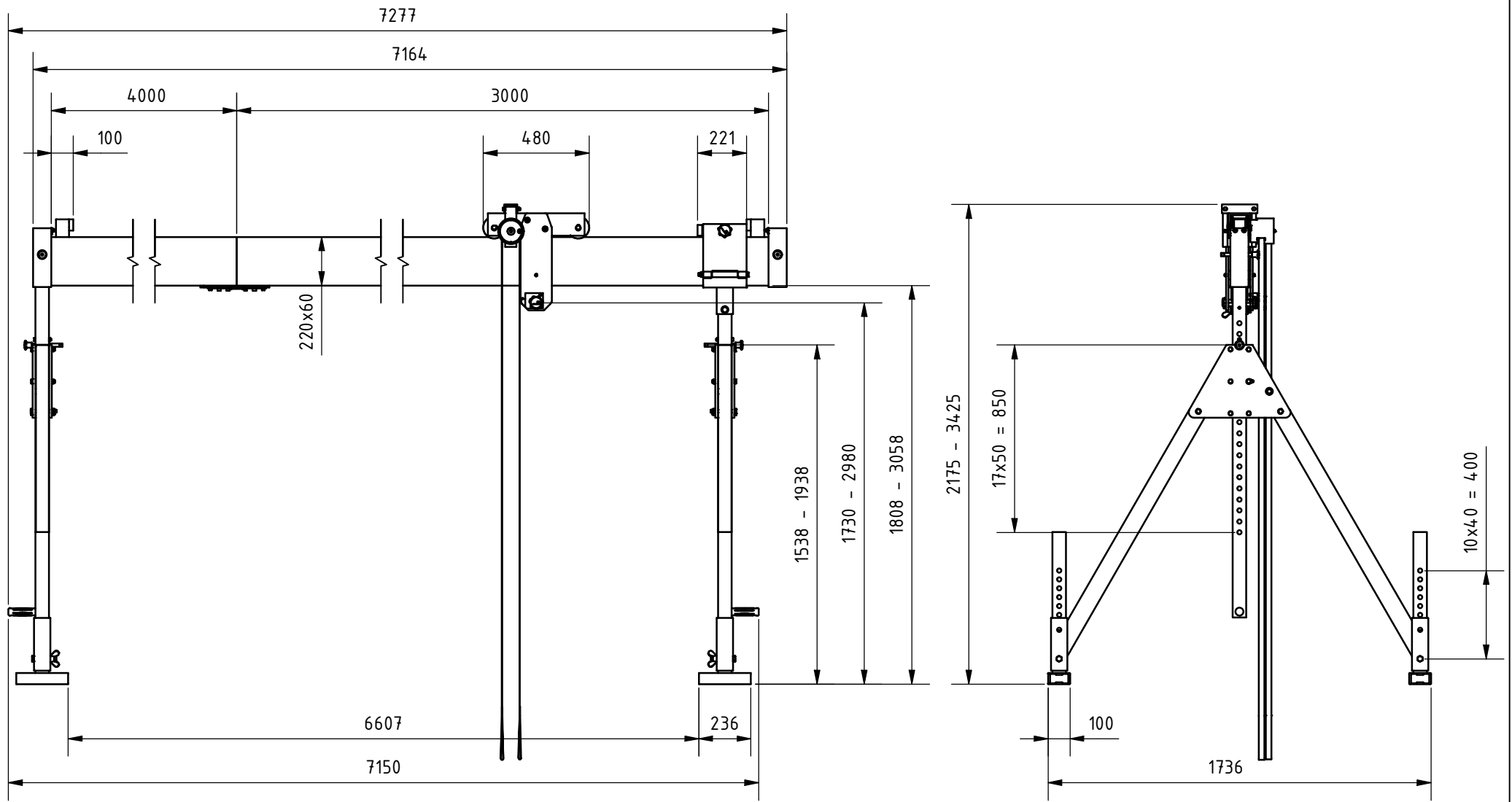
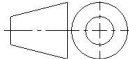

Änd. 1	Änderungsdatum 19.07.2022	Änderung durch Bettina Neuwirth		Allgemeintoleranz ISO 2768 - mK	Artikelnummer 1321070-10	Format A4
 www.schilling-fn.de ■ SCHILLING Kran- und Hebetechnik GmbH ■ Ernst-Zimmermann-Straße 9-11 ■ 88045 Friedrichshafen ■ Deutschland			Zeichnungsnummer 1321070-001		Masse 183,41 kg	Maßstab 1 : 25
			Titel, zusätzlicher Titel Portalkran		Werkstoff	