

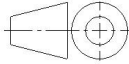
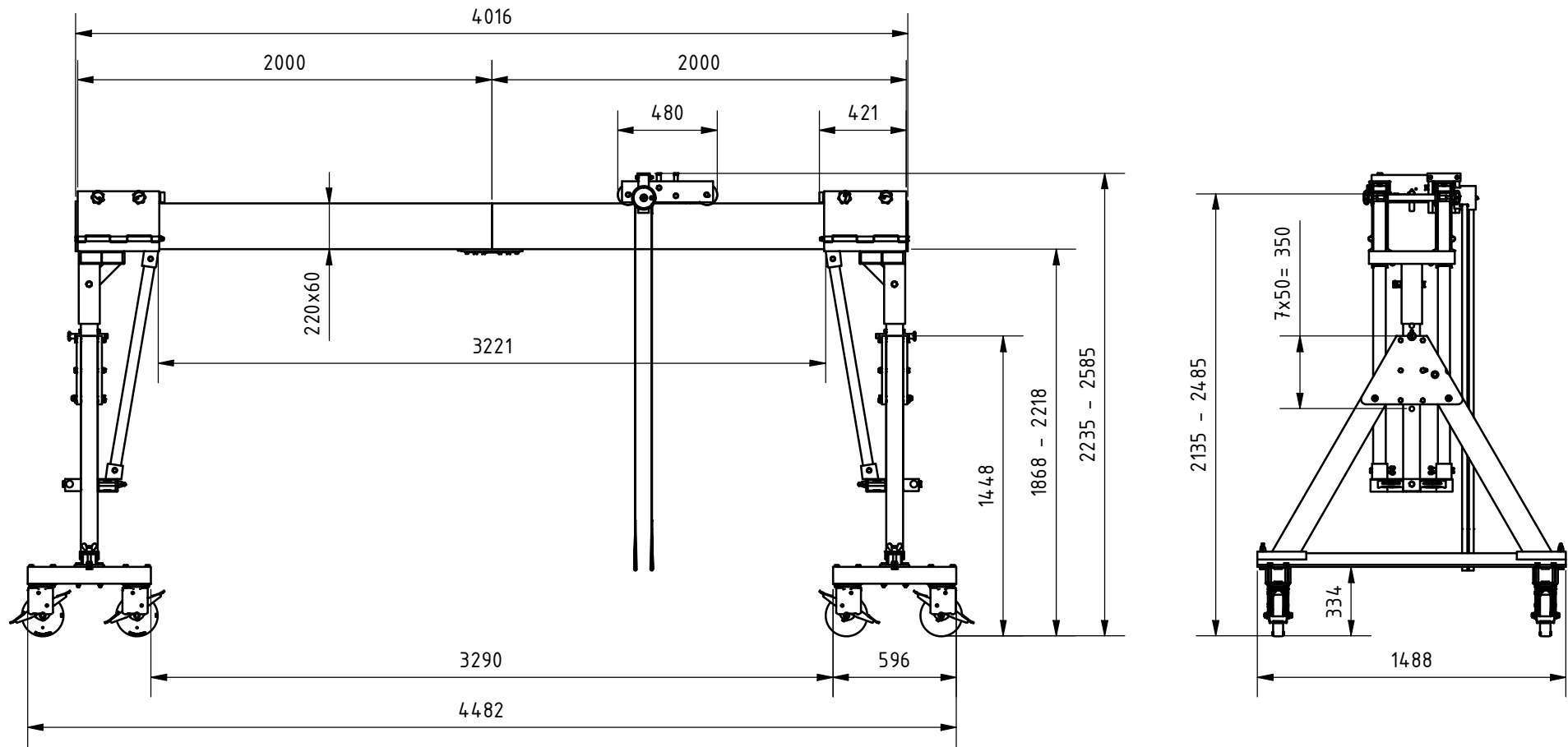

Änd. 4	Änderungsdatum 07.11.2025	Änderung durch Bettina Neuwirth		Allgemeintoleranz ISO 2768 - mK	Artikelnummer 14.402040-10	Format A4
 www.schilling-fn.de <small> ■ SCHILLING Kran- und Hebertechnik GmbH ■ Ernst-Zimmermann-Straße 9-11 ■ 88045 Friedrichshafen ■ Deutschland </small>			Zeichnungsnummer 14.402040-001		Masse 332,71 kg	Maßstab 1 : 30
			Titel, zusätzlicher Titel Portalkran		Werkstoff	



Änd. 4	Änderungsdatum 07.11.2025	Änderung durch Bettina Neuwirth		Allgemeintoleranz ISO 2768 - mK	Artikelnummer 14.402040-10	Format A4
 www.schilling-fn.de ■ SCHILLING Kran- und Hebertechnik GmbH ■ Ernst-Zimmermann-Straße 9-11 ■ 88045 Friedrichshafen ■ Deutschland			Zeichnungsnummer 14402040-001		Masse 332,71 kg	Maßstab 1 : 30
			Titel, zusätzlicher Titel Portalkran		Werkstoff	