

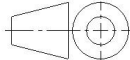
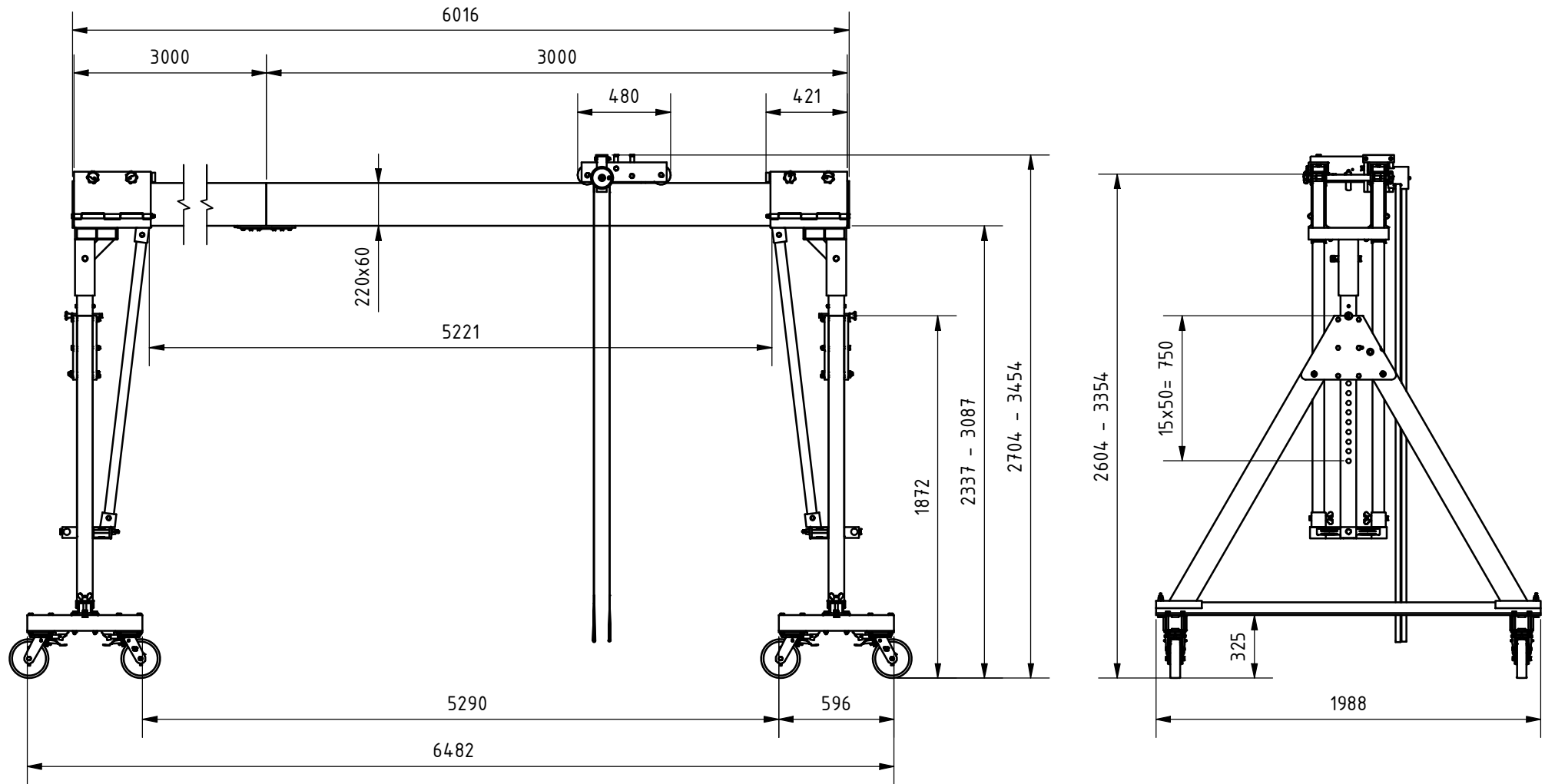

Änd. 5	Änderungsdatum 20.11.2025	Änderung durch Bettina Neuwirth		Allgemeintoleranz ISO 2768 - mK	Artikelnummer 14.501560-10-RI	Format A4
 <a href="http://www.schilling-fn.de">www.schilling-fn.de</a> <small>           ■ SCHILLING Kran- und Hebertechnik GmbH            ■ Ernst-Zimmermann-Straße 9-11            ■ 88045 Friedrichshafen            ■ Deutschland         </small>			Zeichnungsnummer 14.501560-002		Masse 400,64 kg	Maßstab 1 : 35
			Titel, zusätzlicher Titel  Portalkran		Werkstoff	



Änd. 5	Änderungsdatum 20.11.2025	Änderung durch Bettina Neuwirth		Allgemeintoleranz ISO 2768 - mK	Artikelnummer 14.501560-10-RI	Format A4
 <a href="http://www.schilling-fn.de">www.schilling-fn.de</a> ■ SCHILLING Kran- und Hebertechnik GmbH ■ Ernst-Zimmermann-Straße 9-11 ■ 88045 Friedrichshafen ■ Deutschland			Zeichnungsnummer 14.501560-002		Masse 400,64 kg	Maßstab 1 : 30
			Titel, zusätzlicher Titel  Portalkran		Werkstoff	