

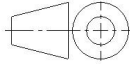



Änd. 4	Änderungsdatum 12.11.2025	Änderung durch Bettina Neuwirth		Allgemeintoleranz ISO 2768 - mK	Artikelnummer 14502060-10	Format A4
 <a href="http://www.schilling-fn.de">www.schilling-fn.de</a> <b>SCHILLING Kran- und Hebertechnik GmbH</b> Ernst-Zimmermann-Straße 9-11      Telefon: +49 7541 60404-0 88045 Friedrichshafen              E-Mail: mail@schilling-fn.de Deutschland			Zeichnungsnummer 14502060-001		Masse 400,45 kg	Maßstab 1 : 35
			Titel, zusätzlicher Titel  Portalkran		Werkstoff	
			Erstellungsdatum 25.03.2020		Erstellt durch Tobias Hornikel	
					Blatt 1/3	

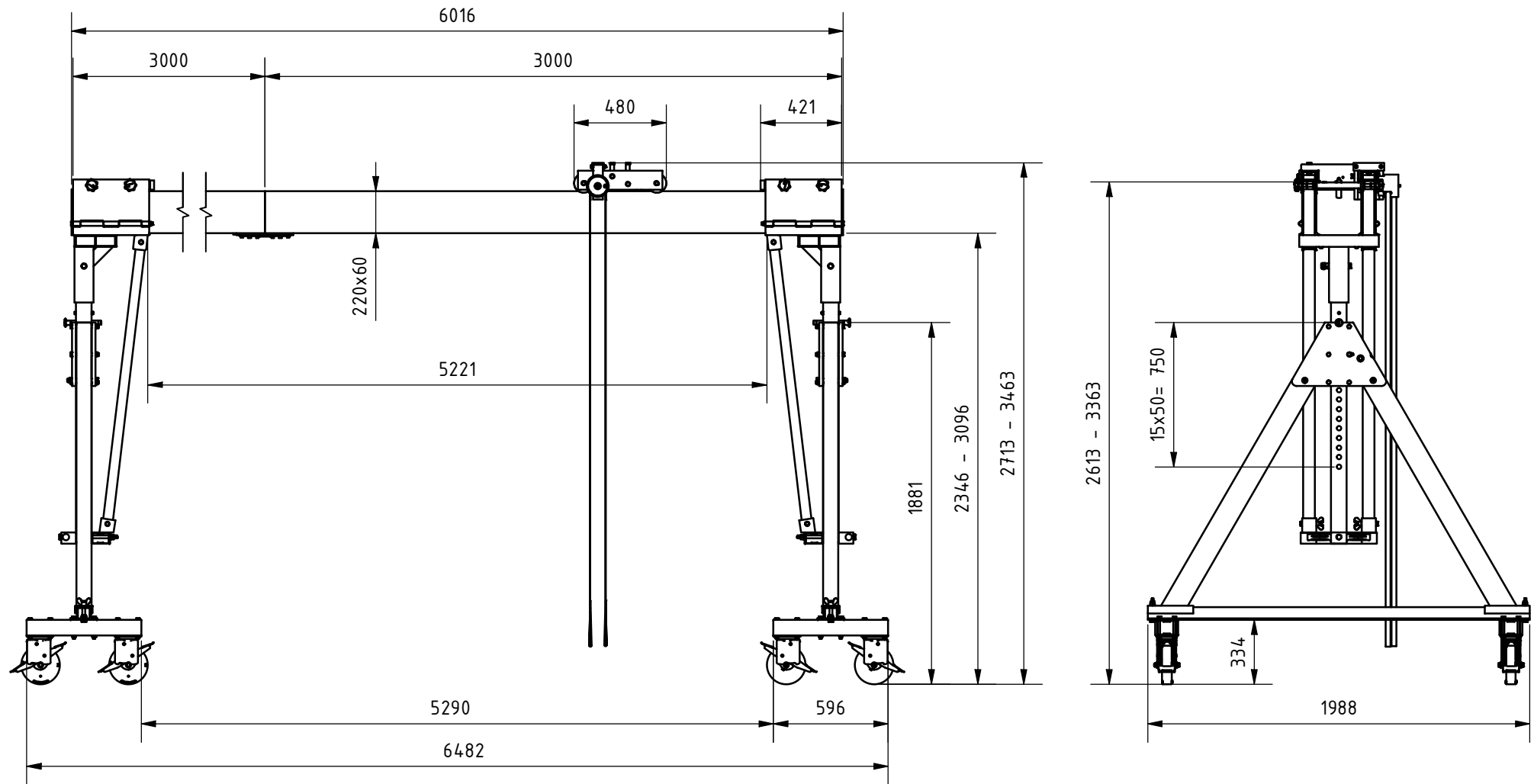
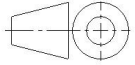

Änd. 4	Änderungsdatum 12.11.2025	Änderung durch Bettina Neuwirth		Allgemeintoleranz ISO 2768 - mK	Artikelnummer 14502060-10	Format A4
 <a href="http://www.schilling-fn.de">www.schilling-fn.de</a> ■ SCHILLING Kran- und Hebertechnik GmbH ■ Ernst-Zimmermann-Straße 9-11 ■ 88045 Friedrichshafen ■ Deutschland			Zeichnungsnummer 14502060-001		Masse 400,45 kg	Maßstab 1 : 30
			Titel, zusätzlicher Titel  Portalkran		Werkstoff	